

LIBRARY SHELVING

S H E L V I N G & D I S P L A Y S Y S T E M S



INTRODUCTION

For nearly fifty years, Spacesaver has been a leader in the storage industry, earning over one hundred patents and thousands of satisfied customers along the way. Today, thousands of libraries around the world rely on us for consistent quality, shelf after shelf, frame after frame. Whether your school is a college or university, public or private, K-12 or special needs, we have the experience to respond creatively and comprehensively to your library's needs. Today, you need to shelve media, and also display and merchandise it. As such, we are continually expanding our line of specialty shelves and accessories, keeping up with the demands of today and tomorrow. At some point you may need to reconfigure – that's where Spacesaver Library Shelving products really pay dividends. Every shelf, frame and accessory is manufactured to the strictest standards, ensuring simple reassembly. In addition, Spacesaver shelving is designed to achieve maximum capacity in both static and mobile configurations.

TABLE OF CONTENTS

PAGE

Frames & Supports	4-5
Base Shelves	6
Adjustable Shelves	6-7
Specialty Shelves	7-8
Accessories	9-10
Options	10-12

PLANNING CANTILEVER SHELVING

MOBILE GUSSETED UNITS (For use on Spacesaver mobile carriages)

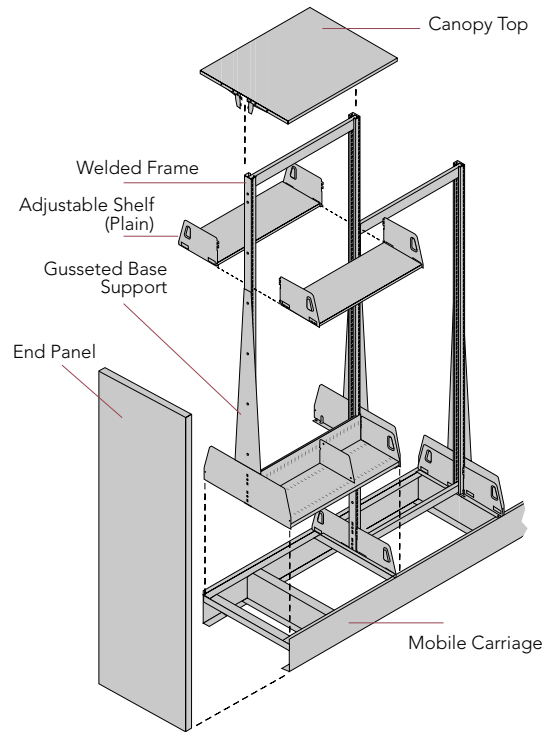

ACTUAL vs. NOMINAL DIMENSIONS

All shelf depth dimensions in the catalog number are actual. For library nominal dimensions, add 1" to the actual depth. See diagram below.

SINGLE FACE & DOUBLE FACE PLAN VIEW DIMENSIONS

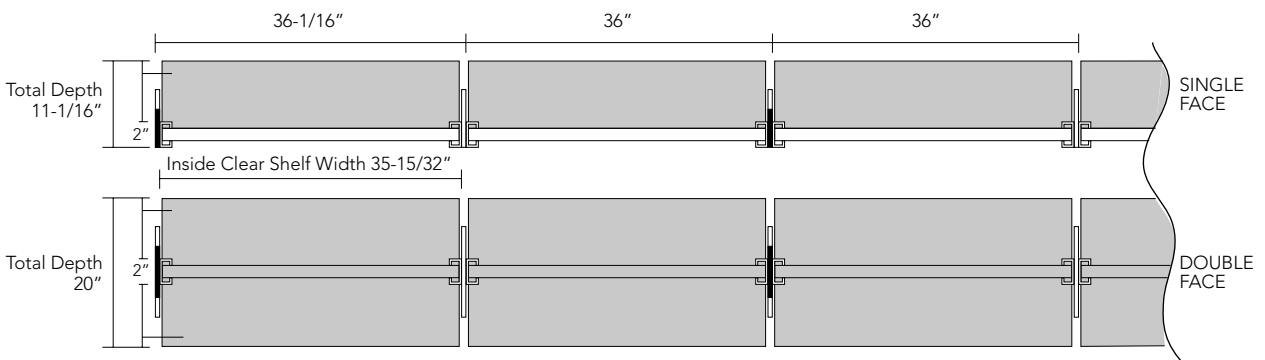

FRAMES & SUPPORTS

WELDED FRAMES

Accepts all shelves and accessory items. Adjustable on 1" increments.
No sway braces to inhibit oversized media from passing center line of bookstack.

Frame Height	Catalog No.*
42"	CWF-4236
66"	CWF-6636
78"	CWF-7836
84"	CWF-8436
90"	CWF-9036

NOTES: *24", 30" and 33.7" widths are available. Change the catalog number accordingly, e.g.:CWF-8430. Consult factory for special heights.

SEISMIC WELDED FRAMES

Accepts all shelves and accessory items. Adjustable on 1" increments.
May be adapted to meet all seismic requirements.*

Frame Height	Catalog No.**
78"	CWF3-7836
84"	CWF3-8436
90"	CWF3-9036

NOTES: *Additional horizontal spreaders available.
**24", 30" and 33.7" widths are available. Change the catalog number accordingly, e.g.:CWF3-8430. Consult factory for special heights.

BASE SUPPORTS

Single face base supports must be specified left or right.

SINGLE FACE

Overall Support Depth	Left End Catalog No.*	Right End Catalog No.*
8"	CSB-6L	CSB-6R
9"	CSB-7L	CSB-7R
10"	CSB-8L	CSB-8R
11"	CSB-9L	CSB-9R
12"	CSB-10L	CSB-10R
13"	CSB-11L	CSB-11R
14"	CSB-12L	CSB-12R
15"	CSB-13L	CSB-13R
16"	CSB-14L	CSB-14R
17"	CSB-15L	CSB-15R
20"	CSB-18L	CSB-18R

DOUBLE FACE

Overall Support Depth	Catalog No.*	Overall Support Depth	Catalog No.*
14"	CDB-6	26"	CDB-12
16"	CDB-7	28"	CDB-13
18"	CDB-8	30"	CDB-14
20"	CDB-9	32"	CDB-15
22"	CDB-10	38"	CDB-18
24"	CDB-11		

NOTE: *Catalog number corresponds to actual depth of Base Shelf used.

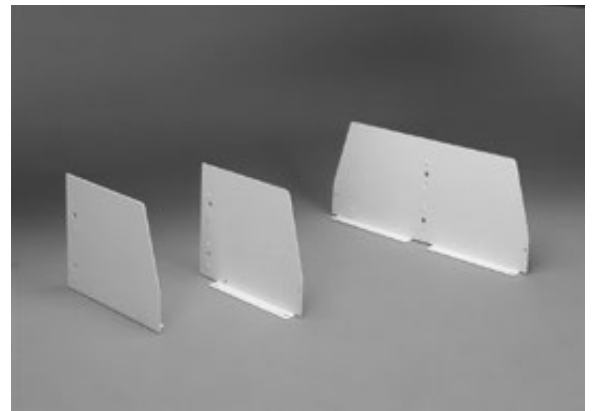
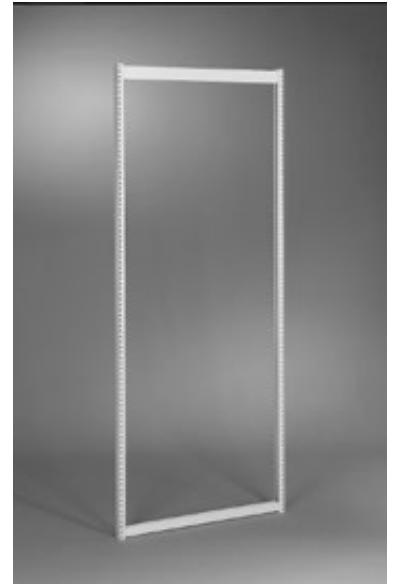

FRAMES & SUPPORTS (continued)



GUSSETED BASE SUPPORTS

For use in seismic and/or mobile shelving applications. Specify single face base supports left or right.

SINGLE FACE: 70" THRU 90" HIGH FRAMES

Overall Support Depth	Left End Catalog No.*	Right End Catalog No.*
8"	CSBG-6L	CSBG-6R
9"	CSBG-7L	CSBG-7R
10"	CSBG-8L	CSBG-8R
11"	CSBG-9L	CSBG-9R
12"	CSBG-10L	CSBG-10R
13"	CSBG-11L	CSBG-11R
14"	CSBG-12L	CSBG-12R
15"	CSBG-13L	CSBG-13R
17"	CSBG-15L	CSBG-15R
20"	CSBG-18L	CSBG-18R

SINGLE FACE: 46" THRU 57" HIGH FRAMES

Overall Support Depth	Left End Catalog No.*	Right End Catalog No.*
8"	CSBG-6L46	CSBG-6R46
9"	CSBG-7L46	CSBG-7R46
10"	CSBG-8L46	CSBG-8R46
11"	CSBG-9L46	CSBG-9R46
12"	CSBG-10L46	CSBG-10R46
13"	CSBG-11L46	CSBG-11R46
14"	CSBG-12L46	CSBG-12R46
15"	CSBG-13L46	CSBG-13R46
17"	CSBG-15L46	CSBG-15R46
20"	CSBG-18L46	CSBG-18R46

SINGLE FACE: 58" THRU 69" HIGH FRAMES

Overall Support Depth	Left End Catalog No.*	Right End Catalog No.*
8"	CSBG-6L58	CSBG-6R58
9"	CSBG-7L58	CSBG-7R58
10"	CSBG-8L58	CSBG-8R58
11"	CSBG-9L58	CSBG-9R58
12"	CSBG-10L58	CSBG-10R58
13"	CSBG-11L58	CSBG-11R58
14"	CSBG-12L58	CSBG-12R58
15"	CSBG-13L58	CSBG-13R58
17"	CSBG-15L58	CSBG-15R58
20"	CSBG-18L58	CSBG-18R58

NOTE: *Catalog number corresponds to actual depth of Base Shelf used.

TRANSVERSE OVERHEAD TIE STRUTS

For extra stabilization overhead when local conditions or regulations require.

Strut Length	Catalog No.
96"	CTTS-96
120"	CTTS-120
Wall Anchor Bracket*	CTSWA
Splice Kit*	CTTS-SK



NOTE: Includes hardware.

DOUBLE FACE: 70" THRU 90" HIGH FRAMES

Overall Support Depth	Catalog No.*
14"	CDBG-6
16"	CDBG-7
18"	CDBG-8
20"	CDBG-9
22"	CDBG-10
24"	CDBG-11
26"	CDBG-12
28"	CDBG-13
32"	CDBG-15
38"	CDBG-18

DOUBLE FACE: 46" THRU 57" HIGH FRAMES

Overall Support Depth	Catalog No.*
14"	CDBG-646
16"	CDBG-746
18"	CDBG-846
20"	CDBG-946
22"	CDBG-1046
24"	CDBG-1146
26"	CDBG-1246
28"	CDBG-1346
32"	CDBG-1546
38"	CDBG-1846

DOUBLE FACE: 58" THRU 69" HIGH FRAMES

Overall Support Depth	Catalog No.*
14"	CDBG-658
16"	CDBG-758
18"	CDBG-858
20"	CDBG-958
22"	CDBG-1058
24"	CDBG-1158
26"	CDBG-1258
28"	CDBG-1358
32"	CDBG-1558
38"	CDBG-1858

WALL COLUMN SUPPORTS

Shelves/accessory components easily be attached to Wall Column Supports for wall-mounted installations*. Column width and depth: 2-3/4" wide x 3/4" deep.

Column Height	Catalog No.*	Column Height	Catalog No.*
42"	CWFC-42	84"	CWFC-84
66"	CWFC-66	90"	CWFC-90
78"	CWFC-78		

NOTES: *If Canopy Tops are desired for use with Wall Column Supports, consult factory. Special heights available. Recommended for concrete or brick walls. To be anchored with the appropriate hardware supplied by the installer for the specific wall material.



BASE SHELVES

Base Shelves include End Brackets. Standard widths of 36", 24" and 30" are available. Change the catalog number accordingly, e.g., CBSPB-2411. If 1" nominal "Base Shelves" are desired, see below for Adjustable Shelves.

3" BASE SHELVES*

3" Base Shelves position media clear of brooms and floor mops.

Actual Shelf Depth	Catalog No.
6"	CBSPB-3606
7"	CBSPB-3607
8"	CBSPB-3608
9"	CBSPB-3609
10"	CBSPB-3610
11"	CBSPB-3611
12"	CBSPB-3612
13"	CBSPB-3613
15"	CBSPB-3615



3" BASE SHELVES w/INTEGRAL LOW-BACK*

Integral Low-Back Shelves are compatible with Integral Low-Back Dividers.

Actual Shelf Depth	Catalog No.
6"	CLBBSB-3606
7"	CLBBSB-3607
8"	CLBBSB-3608
9"	CLBBSB-3609
10"	CLBBSB-3610
11"	CLBBSB-3611
12"	CLBBSB-3612
15"	CLBBSB-3615

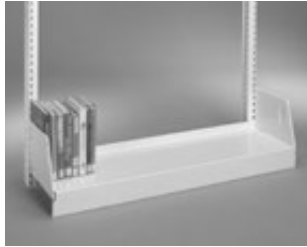

NOTE: Integral Low-Back Dividers (Catalog No. CLBDxx) sold separately. See page 9 for corresponding Integral Low-Back Dividers.

3" SLOTTED BASE SHELVES*

Slotted on 1" centers for Dividers. Includes Slotted Backstop.

Actual Shelf Depth	Catalog No.
6"	CBSSB-3606
7"	CBSSB-3607
8"	CBSSB-3608
9"	CBSSB-3609
10"	CBSSB-3610
11"	CBSSB-3611
12"	CBSSB-3612
15"	CBSSB-3615

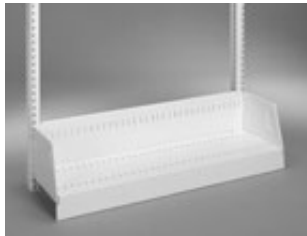

NOTE: Dividers sold separately. See page 8.

3" SLOPED PLAIN BASE SHELVES*

Sloped to aid viewing of items on the bottom shelf.

Actual Shelf Depth	Catalog No.
6"	CBSPB-3606SL
7"	CBSPB-3607SL
8"	CBSPB-3608SL
9"	CBSPB-3609SL
10"	CBSPB-3610SL
11"	CBSPB-3611SL
12"	CBSPB-3612SL
15"	CBSPB-3615SL

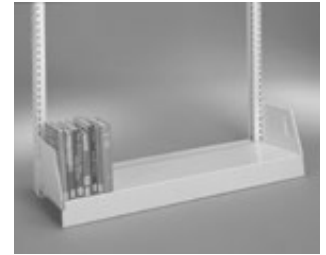

NOTE: If End Panels are used with Sloped Base Shelf, consult factory for End Panel dimension.

3" SLOPED BASE SHELVES w/INTEGRAL LOW-BACK*

Sloped to aid viewing of items on the bottom shelf. Compatible with Integral Low-Back Dividers.

Actual Shelf Depth	Catalog No.
6"	CLBBSB-3606SL
7"	CLBBSB-3607SL
8"	CLBBSB-3608SL
9"	CLBBSB-3609SL
10"	CLBBSB-3610SL
11"	CLBBSB-3611SL
12"	CLBBSB-3612SL
15"	CLBBSB-3615SL



NOTE: Integral Low-Back Dividers (Catalog No. CLBDxx) sold separately. See page 9 for corresponding Integral Low-Back Dividers. If End Panels are used with Sloped Base Shelf, consult factory for End Panel dimension.

3" SLOPED SLOTTED BASE SHELVES*

Slotted on 1" centers for Dividers. Sloped to aid viewing of items on the bottom shelf. Includes Slotted Backstop.

Actual Shelf Depth	Catalog No.
6"	CBSSB-3606SL
7"	CBSSB-3607SL
8"	CBSSB-3608SL
9"	CBSSB-3609SL
10"	CBSSB-3610SL
11"	CBSSB-3611SL
12"	CBSSB-3612SL
15"	CBSSB-3615SL



NOTES: Dividers sold separately. See page 8. If End Panels are used with Sloped Base Shelf, consult factory for End Panel dimension.

ADJUSTABLE SHELVES

Adjustable shelves are available in 24" and 30" widths.

PLAIN ADJUSTABLE SHELVES*

All shelves include End Brackets.

Actual Shelf Depth	Catalog No.
6"	CSPB-3606
7"	CSPB-3607
8"	CSPB-3608
9"	CSPB-3609
10"	CSPB-3610
11"	CSPB-3611
12"	CSPB-3612
13"	CSPB-3613
15"	CSPB-3615

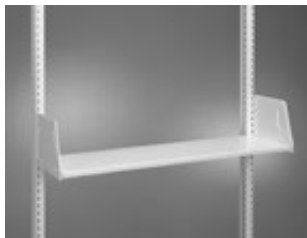

ADJUSTABLE SHELVES w/INTEGRAL LOW-BACK*

Integral Low-Back Shelves are compatible with Integral Low-Back Dividers.

Actual Shelf Depth	Catalog No.
6"	CLBSB-3606
7"	CLBSB-3607
8"	CLBSB-3608
9"	CLBSB-3609
10"	CLBSB-3610
11"	CLBSB-3611
12"	CLBSB-3612
15"	CLBSB-3615



NOTE: Integral Low-Back Dividers (Catalog No. CLBDxx) sold separately. See page 9 for corresponding Integral Low-Back Dividers.

ADJUSTABLE SHELVES (continued)

Shelves include End Brackets. 24" and 30" shelf widths are available. Change the catalog number accordingly. e.g., CSPB-2410. Adjustable Shelves may be used as Base Shelves in conjunction with Adjustable Kick Plates.

SLOTTED ADJUSTABLE SHELVES*

Slotted on 1" centers for Dividers.
Includes Slotted Backstop.

Actual Shelf Depth	Catalog No.
6"	CSSB-3606
7"	CSSB-3607
8"	CSSB-3608
9"	CSSB-3609
10"	CSSB-3610
11"	CSSB-3611
12"	CSSB-3612
15"	CSSB-3615



NOTE: Dividers sold separately. For Dividers, see page 8.
Change dash (-) to "N" for narrow backstop when using a reference shelf.

SLOPED PLAIN ADJUSTABLE SHELVES*

Sloped for easier viewing of displayed items.

Actual Shelf Depth	Catalog No.
6"	CSPB-3606SL
7"	CSPB-3607SL
8"	CSPB-3608SL
9"	CSPB-3609SL
10"	CSPB-3610SL
11"	CSPB-3611SL
12"	CSPB-3612SL
15"	CSPB-3615SL



NOTE: If End Panels are used with Sloped Shelf, consult factory for End Panel dimension.

SLOPED ADJUSTABLE SHELVES w/INTEGRAL LOW BACK*

Sloped to aid viewing of displayed items. Integral Low-Back Shelves are compatible with Integral Low-Back Dividers.

Actual Shelf Depth	Catalog No.
6"	CLBSB-3606SL
7"	CLBSB-3607SL
8"	CLBSB-3608SL
9"	CLBSB-3609SL
10"	CLBSB-3610SL
11"	CLBSB-3611SL
12"	CLBSB-3612SL
15"	CLBSB-3615SL



NOTE: Integral Low-Back Dividers (Catalog No. CLBDxx) sold separately. See page 9 for corresponding Integral Low-Back Divider. If End Panels are used with Sloped Shelf, consult factory for End Panel dimension.

SLOPED SLOTTED ADJUSTABLE SHELVES*

Sloped to aid viewing of displayed items. Includes Slotted Backstop.

Actual Shelf Depth	Catalog No.
6"	CSSB-3606SL
7"	CSSB-3607SL
8"	CSSB-3608SL
9"	CSSB-3609SL
10"	CSSB-3610SL
11"	CSSB-3611SL
12"	CSSB-3612SL
15"	CSSB-3615SL

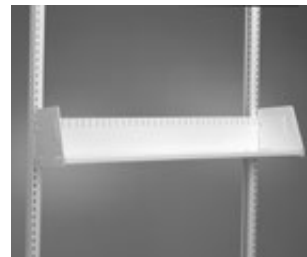

NOTE: Dividers sold separately. For Dividers, see page 8. If End Panels are used with Sloped Shelf, consult factory for End Panel dimension.

SPECIALTY SHELVES

PERIODICAL DISPLAY SHELF (HINGED)*

Sloped display surface (with no exposed fasteners) is 14" high. Flat storage shelf is 12" deep.

Actual Shelf Depth/Display	Catalog No.
12"/14"	CHPD3612
12"/14"	CHPD33612

(Special 3" Base)



NOTE: The vertical opening between the flat shelf and the hinged display shelf (in the open position) is 6" clear. Recommend minimum 14" vertical center-to-center spacing. Front retaining lip is 1" deep.

FIXED DISPLAY SHELF*

11" high, sloped display surface for merchandising of books, tapes and periodicals.

Actual Shelf Depth	Front Up Size	Catalog No.
11"	1"	CFPS1-3611
11"	2"	CFPS2-3611
11"	3"	CFPS3-3611



NOTE: Recommend minimum 11" vertical center-to-center spacing.

PERIODICAL DISPLAY SHELF (HINGED) WITH PLEXIGLAS COVERS

Sloped display is 14" high. Flat storage shelf is 12" deep.

Actual Shelf Depth/Display	Catalog No.
12"/14"	CHPSC-3612*
12"/14"	CHPSC3-3612

(Special 3" Base)



NOTE: The vertical opening between the flat shelf and the hinged display shelf (in the open position) is 6" clear. Recommend minimum 14" vertical center-to-center spacing. Front retaining lip is 1" deep.

FLAT STORAGE SHELF*

Includes End Brackets. Can be used for storage under the Fixed Display Shelf.

Actual Shelf Depth	Catalog No.
11"	CFSSB3611
12"	CFSSB3612
15"	CFSSB3615



SPECIALTY SHELVES (continued)

PULL-OUT REFERENCE SHELF

For convenient referencing. Pull-Out Reference Shelf has a 50 lb. load capacity.

Actual Reference Shelf Width/Depth	To Be Used With Shelf Depth	Catalog No.
32"/9"	8"	CSRS-3609-08
32"/9"	9"	CSRS-3609-09
32"/11"	10"	CSRS-3611-10
32"/11"	11"	CSRS-3611-11
32"/11"	12"	CSRS-3611-12
32"/11"	15"	CSRS-3611-15



NOTE: Requires minimum 1" clear space underneath stationary shelf. Order Shelf separately. Must use narrow backstop.

VHS, CD & PAPERBACK SHELF

Slotted on 1" centers. Includes one (1) Slotted Backstop and four (4) Dividers per shelf. Each shelf holds approximately 26 VHS tapes or 80 CDs.

Actual Shelf Depth	Catalog No.
6"	CPV-3606



NOTE: When storing standard VHS tapes upright, recommend a minimum 10" vertical center-to-center spacing.

2 TIER, SLOPED VHS & CD SHELF

Each 36" wide shelf holds approximately 56 VHS tapes (28 per tier) or 168 CDs (84 per tier). Sloped to aid viewing.

Overall Shelf Depth	Actual End Bracket Height	Catalog No.
14"	11"	CVCD3615DT



NOTE: When storing standard VHS tapes on the second tier, recommend a minimum of 17" vertical center-to-center spacing. Also in 24" and 30" widths. Change the catalog no. accordingly, e.g.: CVCD2415DT. Use CDB-14 base support.

VHS & CD WIRE RACK

One VHS & CD Wire Rack holds 26 VHS tapes or 78 CDs.

Actual Shelf Depth	Catalog No.
6"	CVHSCD-R-36

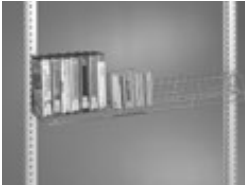

NOTE: When storing standard VHS tapes, recommend a minimum of 10" vertical center-to-center spacing.

2 TIER AUDIO CASSETTE TAPE SHELF

Each 36" wide shelf holds approximately 100 audio cassette tapes (50 per tier).

Actual Shelf Depth	Overall Shelf Height	Catalog No.
6"	7"	CATASB-3606 (Adjustable)
6"	10"	CATBSB-3606 (Base)



NOTE: Recommend a minimum 11" vertical center-to-center spacing. Also in 24" and 30" widths. Change the catalog no. accordingly, e.g., CATASB-3006.

2 TIER MICROFILM SHELF

Each 36" wide shelf holds approximately 40 ea. 13/4" w x 4" d x 4" h microfilm boxes (20 per tier).

Actual Shelf Depth	Overall Shelf Height	Catalog No.
9"	7"	CMSS-3609 (Adjustable)
9"	10"	CMSSB-3609 (Base)



NOTE: Recommend a minimum 10" vertical center-to-center spacing.

MULTIMEDIA BROWSING BOX

Each 36" wide unit stores approximately 56 VHS tapes or 120 CDs. Shown here accepting Snap-In Wire Dividers, catalog no. CHWS-67.

Depth	Height	Catalog No.
12"	6-1/4"	CBBM3612



NOTE: Includes black, non-skid floor mat. CHWS-67 "Snap-In" Wire Dividers sold separately. See page 9. When storing standard VHS tapes, recommend a minimum of 10" vertical center-to-center spacing. 24", 30" and 33.7" shelf widths are available.

1 TIER MULTIMEDIA BROWSING BOX (DIVIDER-TYPE)

Each 36" wide unit stores approximately 56 VHS tapes or 120 CDs.

Depth	Height	Catalog No.
12"	6-1/4"	CBB3612SMM



NOTE: Includes one black, non-skid floor mat. Dividers sold separately. See below for CMMD955 Dividers. When storing standard VHS tapes, recommend a minimum 10" vertical center-to-center spacing.

2 TIER MULTIMEDIA BROWSING BOX (DIVIDER-TYPE)

Each 36" wide unit stores approximately 64 VHS tapes or 132 CDs.

Depth	Height	Catalog No.
15"	8-1/2"	CBB3615SMMMDT



NOTE: Includes two black, non-skid floor mats. Dividers sold separately. See below for CMMD568 Dividers. When storing standard VHS tapes, recommend a minimum 12" vertical center-to-center spacing.

MULTIMEDIA BROWSING BOX DIVIDERS

For Browsing Box Type	Catalog No.
1 TIER (CBB3612SMM)	CMMD955
2 TIER (CBB3615SMMMDT)	CMMD568

Media	Quantity of Dividers Per Tier
CD'S	5
VHS TAPES	7
MICROFILM BOXES	7
AUDIO CASSETTE TAPES	11

ACCESSORIES

ZIGZAG DISPLAY BACKSTOP

For merchandising a variety of audio-visual and paperback media.

Height	Catalog No.
3-3/4"	CZBS-36

NOTE: Includes Backstop and fasteners only. Order Shelf separately.



CENTERSTOP* (Offset for back-to-back shelving)

Eliminates the need for individual backstops.

Height	Catalog No.
3-3/4"	CCS-36

NOTE: Order Shelves separately.

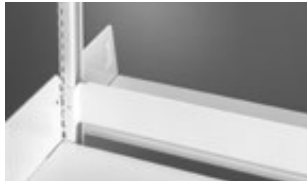

PLAIN BACKSTOP* (Narrow)

Order one (1) per shelf.

Height	Catalog No.
3-3/4"	CABP36

NOTE: Order Shelves separately.



SLOTTED BACKSTOP* (Narrow)

Order one (1) per shelf..

Height	Catalog No.
3-3/4"	CABS36

NOTE: Order Shelves separately.

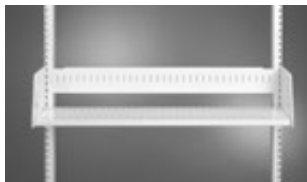

PLAIN BACKSTOP* (Full height)

Interlocks with shelf. Order one (1) per shelf.

Height	Catalog No.
6"	CPBS-36



SLOTTED BACKSTOP* (Full height)

Interlocks with shelf. Order one (1) per shelf.

Height	Catalog No.
6"	CSBS-36



DIVIDERS

Dividers are all 6" high.

Actual Shelf Depth	Catalog No.
6"	CFD-6
7"	CFD-7
8"	CFD-8
9"	CFD-9
10"	CFD-10
11"	CFD-11
12"	CFD-12
15"	CFD-15



6 TIER NEWSPAPER RACK

Display up to 6 newspapers.

Catalog No.
CNR615

NOTE: For 36" newspaper sticks. Newspaper sticks not included. End bracket depth 12".



MEDIA BAG RACK

Hang large or small media bags on this 36" rod. Includes deflection inhibiting low-back shelf, clip and end brackets.

Will Accommodate Media Bags Up To	Actual End Bracket Depth	Shelf Depth	Catalog No.
12" deep	10"	6"	CMHR3610
20" deep	12"	10"	CMHR3612

NOTE: Media bags not included.



STEEL BOOK SUPPORTS

A. FINDABLE BOOK SUPPORT

Eliminates searching for book supports between books.

Height	Pad Type	Catalog No.
6"	W/full cork base	CBE-06NL
9"	W/full cork base	CBE-09NL
10"	W/full cork base	CBE-10NL
6"	W/magnetic base	CBE-06NLM
9"	W/magnetic base	CBE-09NLM
10"	W/magnetic base	CBE-10NLM

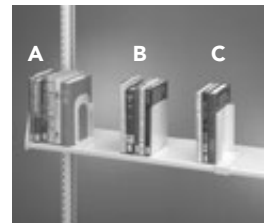

B. FLAT BOOK END

Place media on top of the Flat Book End for support.

Height	Catalog No.
4"	CACD-4
6"	CBE-06
9"	CBE-09

NOTE: Includes full cork base.

C. CLIP ON BOOK SUPPORT

Easy to locate the "Clip-On" Book Support since it clips on the shelf front.

Height	Catalog No.
9"	CCOD9

NOTE: Includes full cork base.

ACCESSORIES (continued)

"W" HANGING WIRE SUPPORT (Squeeze Type)

Available in three (3) sizes for five (5) different shelf depths.

Actual Shelf Depth	Catalog No.
8" & 9"	CWWS08
10" & 11"	CWWS10
12"	CWWS12
15"	CWWS15

NOTE: If used with canopy tops, order the canopy tops specified for wire supports.



"SNAP IN" HANGING WIRE BOOK SUPPORT

Hanging Wire Book Supports come in four (4) different sizes.

Actual Shelf Depth	Catalog No.
6" & 7"	CHWS-67*
8" & 9"	CHWS-89
10", 11" & 12"	CHWS-1012
15"	CHWS-15

NOTE: * CHWS-67 also works with Multimedia Browsing Box, catalog no. CBBM3612. CHWS-67 is "V" shape.



INTEGRAL LOW-BACK DIVIDERS (For Integral Low-Back Shelves)

Available in three (3) sizes for five (5) different shelf depths.

Actual Shelf Depth	Catalog No.
8" & 9"	CLBD08
10", & 11"	CLBD10
12"	CLBD12

NOTE: Order Integral Low-Back Shelf separately.



RANGE FINDER & CARD HOLDERS

Type	Size	Catalog No.
A-Range Finder	3"H x 5"D	RFST35
B-Continuous Card Holder	4"H	CSIHww*
C-3x5 Card Holder	3"H x 5"D	CHST35

*Where "ww" is the actual End Panel width, e.g. Use CSIH20 for a 20" wide End Panel.

NOTE: A & B available in the color to match the color of shelving ordered. C available in black finish. B & C include double-back tape.



SHELF LABEL HOLDERS

Type	Width	Catalog No.
A-Clear Plastic	5"	CLH-05
B-Magnetic	36"	LH-36

NOTE: Both A & B include paper label inserts.



*24" and 30" widths available.

CANOPY TOP*

Includes mounting brackets.

Overall Top Depth	Actual Shelf Depth	Catalog No.
SINGLE FACE		
8"	6"	CCTSB-3606
9"	7"	CCTSB-3607
10"	8"	CCTSB-3608
11"	9"	CCTSB-3609
12"	10"	CCTSB-3610
13"	11"	CCTSB-3611
14"	12"	CCTSB-3612
15"	13"	CCTSB-3613
17"	15"	CCTSB-3615
20"	18"	CCTSB-3618
DOUBLE FACE		
14"	6"	CCTDB-3606
16"	7"	CCTDB-3607
18"	8"	CCTDB-3608
20"	9"	CCTDB-3609
22"	10"	CCTDB-3610
24"	11"	CCTDB-3611
26"	12"	CCTDB-3612
28"	13"	CCTDB-3613
32"	15"	CCTDB-3615
38"	18"	CCTDB-3618



*NOT A WEIGHT BEARING SHELF.

NOTE: Not compatible with "W" Hanging Wire Dividers. When "W" Hanging Wire Dividers are used, change "-" to "W" for a Canopy Top which will accommodate "W" Hanging Wire Dividers, e.g., CCTDBW3609.

CANOPY LIGHT

Illuminate display shelves or brighten dimly lit alcoves. Includes white prismatic diffuser.

Width	Depth	Catalog No.
36"	20-1/2"	CCLIGHT3621

NOTE: Internal, UL listed 24" light fixture accepts 2-24" long bulbs. Bulbs not included. Light housing is 12-3/8" deep and 5" high. 36" frame width only.



BRACKETS FOR LAMINATED CANOPY TOP

Fasteners included.

Actual Overall Top Depth	Left End Catalog No.	Right End Catalog No.
6", 7" & 8"	CCTBL-6L	CCTBL-6R
9", 10", 11", 12", & 15"	CCTBL-15L	CCTBL-15R

NOTE: Order left and right brackets separately. In the photo, one CCTBL-15L and one CCTBL-15R are shown in conjunction with a 20" deep (overall) laminated canopy top which was designed to accommodate actual 9" deep shelves.



BASE SHELF FILLER*

Fills the space between the two back-to-back Base Shelves.

Shelf Depth	Catalog No.
36"	CBSF-36
(For use with 3" Base Shelf.)	
36"	CBSF1-36
(For use with 1" Base Shelf.)	

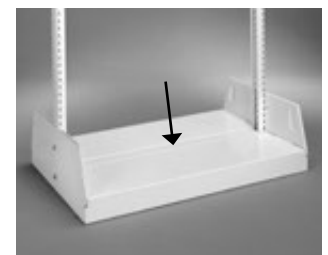

ACCESSORIES (continued)

ADJUSTABLE SHELF FILLER*

Fills the space between two back-to-back Adjustable Shelves.

Shelf Width	Catalog No.
36"	CASF36

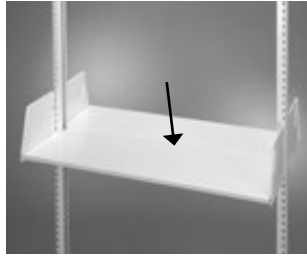

ADJUSTABLE KICK PLATES*

Adjustable Kick Plates may be used when Adjustable Shelves are used as Base Shelves.

Kick Plate Type	Catalog No.
RECESSED**	CKP36
FLUSH (Not Shown)	CFKP36

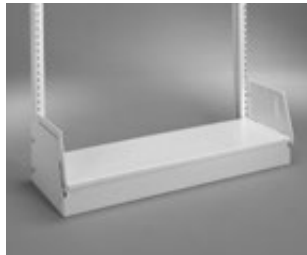

NOTE: Adjustable, Flush Kick Plate not shown.

** Base supports must be 1" less than shelf depth when using Adjustable Recessed Kick Plate.

Both types include mounting hardware.

Both may be used with or without levelers.

Requires an additional 1" of frame height when used with no leveler kits.

LEVELER KITS

Use when floor is out of level.

No. Of Leveling Feet Per Kit	Actual Base Support Depths	Catalog No.
SINGLE FACE		
3	8", 9" & 10"	CSFL0608
4	11", 12", 13", 14", & 17"	CSFL0915
DOUBLE FACE		
4	14", 16" & 18"	CDFL0608
6	20", 22", 24", 26" & 32"	CDFL0915

NOTE: Order one (1) kit per base support .



WALL ATTACHMENT BRACKET

For attaching single face Welded Frames to a wall.

Catalog No.
CWAB



NOTE: Fastening hardware not included since wall material may vary.

OPTIONS (continued)

END PANEL MOUNTING BRACKETS

For use on both Metal End Panels and Laminate End Panels when Canopy Top is not used. Double face bracket shown.

SINGLE FACE

Actual Shelf Depth	Catalog No.
6"	CMEPSS08L
6"	CMEPSS08R
7"	CMEPSS09L
7"	CMEPSS09R
8"	CMEPSS10L
8"	CMEPSS10R
9"	CMEPSS11L
9"	CMEPSS11R
10"	CMEPSS12L
10"	CMEPSS12R
11"	CMEPSS13L
11"	CMEPSS13R
12"	CMEPSS14L
12"	CMEPSS14R
13"	CMEPSS15L
13"	CMEPSS15R
15"	CMEPSS17L
15"	CMEPSS17R
16"	CMEPSS18L
16"	CMEPSS18R

DOUBLE FACE

Actual Shelf Depth	Catalog No.
6"	CMEPSD14
7"	CMEPSD16
8"	CMEPSD18
9"	CMEPSD20
10"	CMEPSD22
11"	CMEPSD24
12"	CMEPSD26
13"	CMEPSD28
15"	CMEPSD32
18"	CMEPSD38

NOTE: Order one (1) per End Panel.



OPTIONS (continued)

CLOSURE PANELS

May be used to enclose backside of the End Panels. Match the End Panel size.

SINGLE FACE

End Panel Width	Catalog No.
78" FRAME HEIGHT	
8"	CCP-0878
9"	CCP-0978
10"	CCP-1078
11"	CCP-1178
12"	CCP-1278
13"	CCP-1378
14"	CCP-1478S
17"	CCP-1778
84" FRAME HEIGHT	
8"	CCP-0884
9"	CCP-0984
10"	CCP-1084
11"	CCP-1184
12"	CCP-1284
13"	CCP-1384
14"	CCP-1484S
17"	CCP-1784 8
90" FRAME HEIGHT	
8"	CCP-0890
9"	CCP-0990
10"	CCP-1090
11"	CCP-1190
12"	CCP-1290
13"	CCP-1390
14"	CCP-1490S
17"	CCP-1790

DOUBLE FACE

End Panel Width	Catalog No.
78" FRAME HEIGHT	
14"	CCP-1478D
16"	CCP-1678
18"	CCP-1878
20"	CCP-2078
22"	CCP-2278
24"	CCP-2478
26"	CCP-2678
32"	CCP-3278
84" FRAME HEIGHT	
14"	CCP-1484D
16"	CCP-1684
18"	CCP-1884
20"	CCP-2084
22"	CCP-2284
24"	CCP-2484
26"	CCP-2684
32"	CCP-3284
90" FRAME HEIGHT	
14"	CCP-1490D
16"	CCP-1690
18"	CCP-1890
20"	CCP-2090
22"	CCP-2290
24"	CCP-2490
26"	CCP-2690
32"	CCP-3290

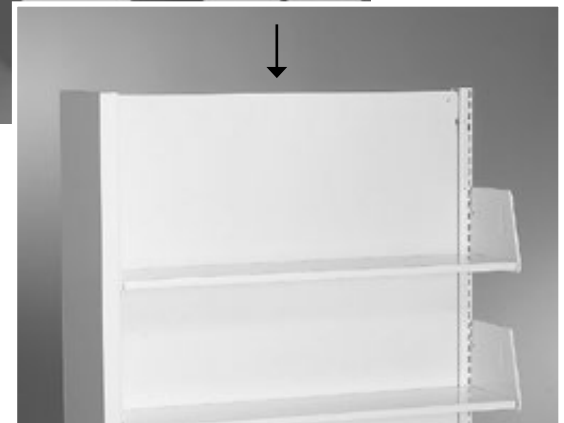

NOTE: Also available in 24" and 30" widths. Change the catalog no. accordingly, e.g.: CBPF-4224.

CLOSED BACK KITS

Fills the space between the upright frame. Kits include two (2) Upright Fillers (hidden from view).

Frame Height	Catalog No.	Frame Height	Catalog No.
42"	CBPF-4236	84"	CBPF-8436
66"	CBPF-6636	90"	CBPF-9036
78"	CBPF-7836		

INTERMEDIATE WALL FILLERS

Fills the rectangular void created when two single face sections are placed at a right angle with a double face section. Specify overall unit depths (ds & dd) and frame height used (ht).

Catalog No.
CIF-dsdddsh

NOTE: ds = overall depth of the single face unit in inches (including the 2" frame) dd = overall depth of the double face unit in inches (including the 2" frame) ht = height of the adjoining Welded Frame, e.g., CIF-11201184 (for shelves with an actual depth of 9").

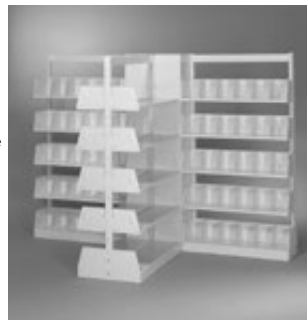

CORNER FILLERS

Fills the corner void created when single face sections are placed at right angles. Specify overall unit depths (dsds) and frame height used (ht).

Catalog No.
CCF-dsdsht

NOTE: ds = overall depth of the single face unit in inches (including the 2" frame) ht = height of the adjoining Welded Frame, e.g., CCF-111184 (for shelves with an actual depth of 9").



OPTIONS (continued)

METAL END PANELS

Use to finish off the exposed ends of shelving ranges.
Metal End Panels are 1-1/2" thick .

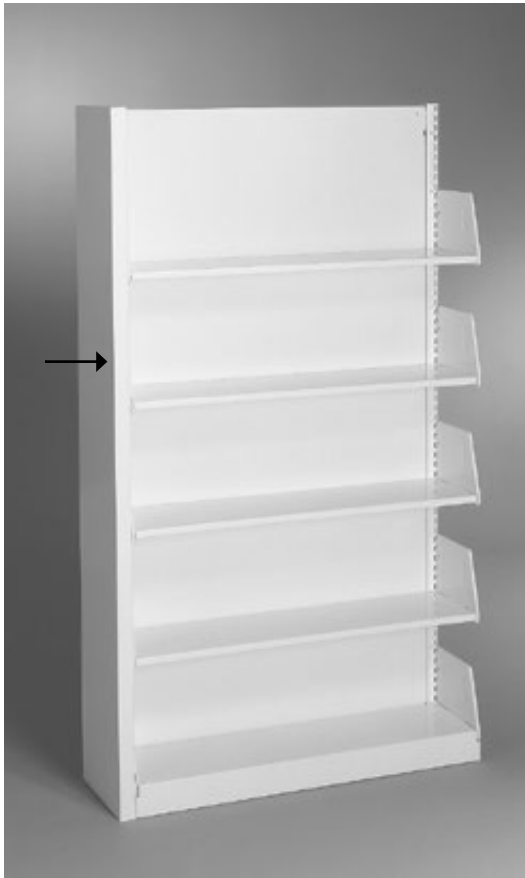

NOTE: End Panels should be sized to cover the overall base depth.
(overall base shelf depth = actual shelf depth + 2" frame.)
End Panel Mounting Brackets sold separately. See page 12.

SINGLE FACE

Actual Shelf Depth	Catalog No.
42" UPRIGHT HEIGHT	
6"	CRMEP4208
7"	CRMEP4209
8"	CRMEP4210
9"	CRMEP4211
10"	CRMEP4212
11"	CRMEP4213
12"	CRMEP4214
13"	CRMEP4215
15"	CRMEP4217
66" UPRIGHT HEIGHT	
6"	CRMEP6608
7"	CRMEP6609
8"	CRMEP6610
9"	CRMEP6611
10"	CRMEP6612
11"	CRMEP6613
12"	CRMEP6614
13"	CRMEP6615
15"	CRMEP6617
78" UPRIGHT HEIGHT	
6"	CRMEP7808
7"	CRMEP7809
8"	CRMEP7810
9"	CRMEP7811
10"	CRMEP7812
11"	CRMEP7813
12"	CRMEP7814
13"	CRMEP7815
15"	CRMEP7817
84" UPRIGHT HEIGHT	
6"	CRMEP8408
7"	CRMEP8409
8"	CRMEP8410
9"	CRMEP8411
10"	CRMEP8412
11"	CRMEP8413
12"	CRMEP8414
13"	CRMEP8415
15"	CRMEP8417
90" UPRIGHT HEIGHT	
6"	CRMEP9008
7"	CRMEP9009
8"	CRMEP9010
9"	CRMEP9011
10"	CRMEP9012
11"	CRMEP9013
12"	CRMEP9014
13"	CRMEP9015
15"	CRMEP9017

DOUBLE FACE

Actual Shelf Depth	Catalog No.
42" UPRIGHT HEIGHT	
6"	CRMEP4214D
7"	CRMEP4216D
8"	CRMEP4218D
9"	CRMEP4220D
10"	CRMEP4222D
11"	CRMEP4224D
12"	CRMEP4226D
13"	CRMEP4228D
15"	CRMEP4232D
66" UPRIGHT HEIGHT	
6"	CRMEP6614D
7"	CRMEP6616D
8"	CRMEP6618D
9"	CRMEP6620D
10"	CRMEP6622D
11"	CRMEP6624D
12"	CRMEP6626D
13"	CRMEP6628D
15"	CRMEP6632D
78" UPRIGHT HEIGHT	
6"	CRMEP7814D
7"	CRMEP7816D
8"	CRMEP7818D
9"	CRMEP7820D
10"	CRMEP7822D
11"	CRMEP7824D
12"	CRMEP7826D
13"	CRMEP7828D
15"	CRMEP7832D
84" UPRIGHT HEIGHT	
6"	CRMEP8414D
7"	CRMEP8416D
8"	CRMEP8418D
9"	CRMEP8420D
10"	CRMEP8422D
11"	CRMEP8424D
12"	CRMEP8426D
13"	CRMEP8428D
15"	CRMEP8432D
90" UPRIGHT HEIGHT	
6"	CRMEP9014D
7"	CRMEP9016D
8"	CRMEP9018D
9"	CRMEP9020D
10"	CRMEP9022D
11"	CRMEP9024D
12"	CRMEP9026D
13"	CRMEP9028D
15"	CRMEP9032D

Spacesaver 
Specialists, Inc.
Your Storage Planning & Equipment Source

Serving Oregon and SW Washington

Spacesaver Specialists, Inc.
9730 SW Herman Road
Tualatin, OR 97062
503-612-2600
www.storageplanning.com

 **Spacesaver**[®]

Spacesaver Corporation 1450
Janesville Avenue
Fort Atkinson, WI 53538-2798
800.492.3434
www.spacesaver.com

©2019 Spacesaver Corporation. Spacesaver is a subsidiary of KI.
All Rights Reserved.